

GLSV-200 series

200W Constant Voltage Outdoor LED Power Supply



Features:

- Constant voltage design
- Built-in active PFC function
- Universal AC input / Full range up to 305VAC
- Protections: Short Circuit / Over Voltage / Over Current / Over temperature
- Surge immunity: Differential Mode – 5kV, Common Mode - 10kV
- Cooling by free air convection
- IP67 design for indoor and outdoor applications

Application:





















- Landscape lighting
- LED street lighting
- Industrial lighting



© MODEL INFORMATION

Model Number	Output Power [W]	Output Voltage [V]	Output Current [A]	Efficiency typ. [%]	Power Factor typ.
GLSV-200B012	200.04	12	16.67	91%	0.96
GLSV-200B024	199.92	24	8.33	92%	0.96
GLSV-200B036	200.16	36	5.56	92%	0.96
GLSV-200B048	200.16	48	4.17	92%	0.96

© APPROVAL MARKS and SYMBOLS

GLSV-200B012	    	RoHS IP67 SELV	tc: 85°C ta: 50°C	
GLSV-200B024	    	RoHS IP67 SELV	tc: 85°C ta: 50°C	
GLSV-200B036	    	RoHS IP67 SELV	tc: 85°C ta: 50°C	
GLSV-200B048	    	RoHS IP67 SELV	tc: 85°C ta: 50°C	

© MODEL ENCODING

GLSV	-	200	B	xxx
Series name		Rated Output Power [W]	Option name	012 - rated output voltage is 12V 024 - rated output voltage is 24V 036 - rated output voltage is 36V 048 - rated output voltage is 48V

GLSV-200 series

200W Constant Voltage Outdoor LED Power Supply



© ELECTRICAL SPECIFICATION

MODEL	GLSV-200B012	GLSV-200B024	GLSV-200B036	GLSV-200B048
OUTPUT				
OUTPUT VOLTAGE	12VDC	24VDC	36VDC	48VDC
NO LOAD VOLTAGE (MAX.)	12.6VDC	25.2VDC	37.8VDC	50.4VDC
LOAD CURRENT RANGE	0 ÷ 16.67A	0 ÷ 8.33A	0 ÷ 5.56A	0 ÷ 4.17A
RATED POWER	200.04W	199.92W	200.16W	200.16W
OUTPUT VOLTAGE PRECISION	± 5.0%			
LINE REGULATION (FROM 115VAC TO 305VAC)	± 3.0%			
LOAD REGULATION (FROM 50% TO 100% LOAD)	± 3.0%			
OUTPUT VOLTAGE RIPPLE	< 3% V _{OUT}		< 2% V _{OUT}	
TURN-ON DELAY TIME	0.5s for 100% load 230VAC / 1s for 100% load 115VAC			

INPUT				
VOLTAGE RANGE	90 ÷ 305VAC (Refer to Input Voltage vs. Load Curve)			
FREQUENCY RANGE	47 ÷ 63Hz			
EFFICIENCY AT 100% LOAD (TYP.)	91%	92%	92%	92%
	Refer to Efficiency vs. Output Load Curve			
AC CURRENT (MAX.)	2.8A			
INRUSH CURRENT (MAX.)	150A / 230VAC (Refer to Inrush Current Waveform)			
LEAKAGE CURRENT (MAX.)	0.75mA/230VAC			
POWER FACTOR (TYP.)	0.96 / 230VAC at 100% load (Refer to Power Factor vs. Load Curve)			
THD	< 15% / 230VAC at 70-100% load (Refer to THD vs. Load Curve)			

PROTECTIONS				
SHORT CIRCUIT	Type: decrease of input power, auto-recovery.			
OVER VOLTAGE	13.2 ÷ 15.6VDC	26.4 ÷ 31.2VDC	39.6 ÷ 46.8VDC	52.8 ÷ 62.4VDC
	Type: shut off output voltage, re-power on to recovery.			
OVER CURRENT	100-160% rated output current		110-160% rated output current	
	Type: hiccup mode, auto-recovery.		Type: constant current, auto-recovery.	
OVER TEMPERATURE	Temperature T _c > 90°C			
	Type: shut off output voltage, re-power on to recovery.			

WORKING ENVIRONMENT	
WORKING TEMPERATURE	-40°C ÷ 60°C (Refer to Derating Curve)
WORKING HUMIDITY	20 ÷ 95% RH non-condensing
STORAGE TEMPERATURE AND HUMIDITY	-40°C ÷ 85°C, 20 ÷ 95% RH non-condensing
VIBRATION	10 to 500Hz sweep at constant acceleration 1G (depth 3.5mm) for 1 hour for each X, Y, Z axes
DEGREE OF PROTECTION	[2] IP67

GLSV-200 series

200W Constant Voltage Outdoor LED Power Supply



SAFETY AND EMC REGULATIONS

SAFETY STANDARDS	CE	EN61347-1; EN61347-2-13
EMC STANDARDS	CE	EN55015; IEC61000-3-2; IEC61000-3-3; IEC61547
WITHSTAND VOLTAGE	IN/OUT: 3.75kVAC; IN/GND: 1.6kVAC; OUT/GND: 0.5kVAC; 60s, current < 10mA	
GROUNDING RESISTANCE	< 0.1Ω (60S/25A)	
INSULATION RESISTANCE	IN/OUT, IN/GND, OUT/GND > 100MΩ (500VDC/60s)	

OTHERS

Input Wire	CCC+VDE 3 x 1.0mm ² , length = 300 ± 10mm
Output Wire	14AWG 2C, length = 300 ± 10mm for GLSV-200B012 and GLSV-200B024 CCC+VDE 2 x 1.0mm ² , length = 300 ± 10mm for GLSV-200B036 and GLSV-200B048
MTBF (MIL-HDBK-217F)	200 000h at 230VAC / 80% load and ta < 25°C
Life Time (min.)	50 000h at 230VAC / 100% load and tc < 70°C (Refer to Life Time vs. T _c Curve)
Dimensions (Length * Width x Height)	232.0 * 68.0 * 43.5 mm for GLSV-200B012 and GLSV-200B024 248.0 * 68.0 * 43.5 mm for GLSV-200B036 and GLSV-200B048
Weight	1350 ± 100g

1. All parameters NOT specially mentioned are measured at 230VAC input, rated load and 25°C of ambient temperature.
2. Suitable for indoor or outdoor use. Please avoid direct exposure to sunlight and immersion in water for over 30 minutes.
3. Power supply is considered as component not indented to apply by end-user. Power supply meets safety and EMC standards however the final equipment with power supply must be re-quality to comply with EMC and LVD Directives.

© MECHANICAL SPECIFICATION

**GLSV-200B012
GLSV-200B024**

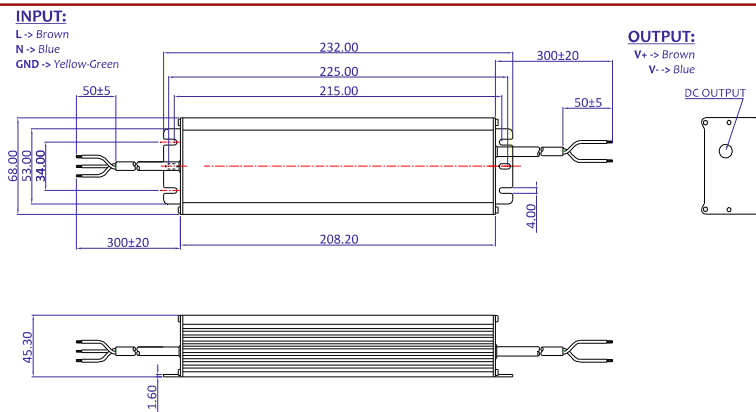

**GLSV-200B036
GLSV-200B048**

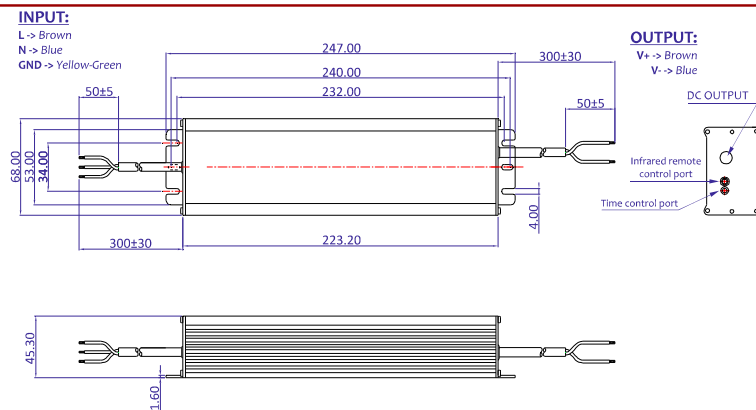

Power Factor vs. Load Curve

GLSV-200 series

200W Constant Voltage Outdoor LED Power Supply



GLSV-200B012

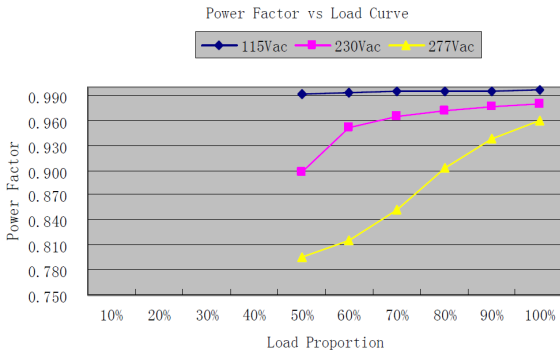

GLSV-200B024

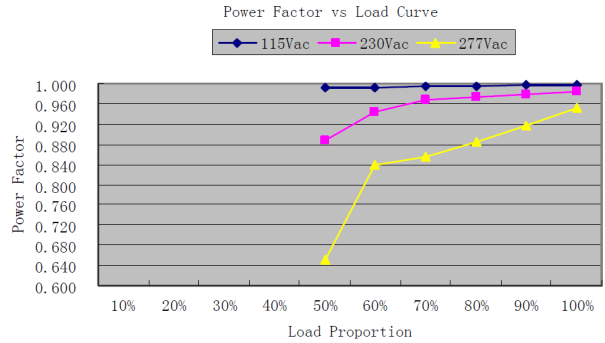

GLSV-200B036

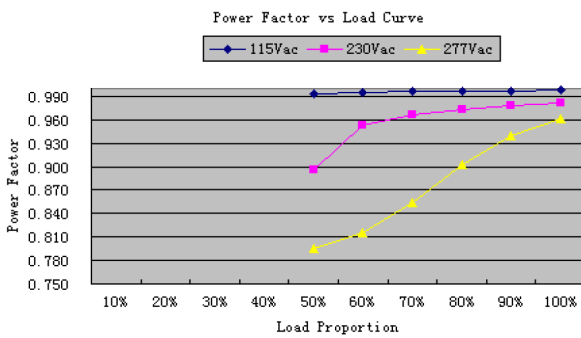

GLSV-200B048

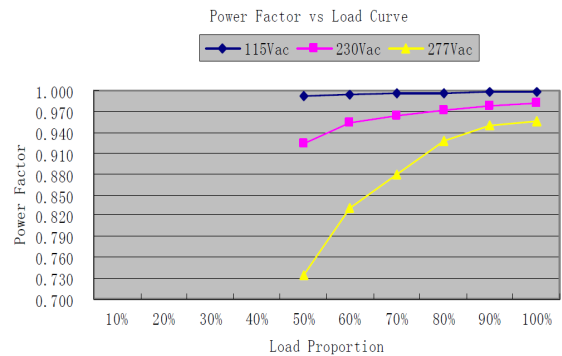

© Efficiency vs. Load Curve

GLSV-200B012

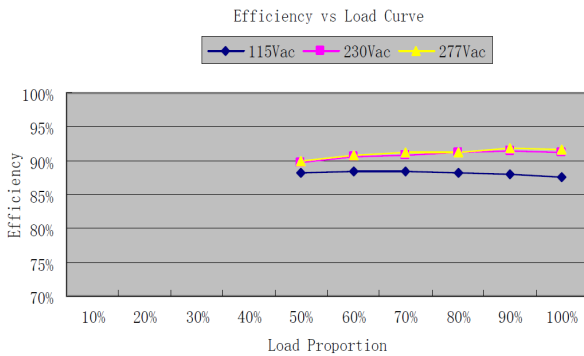

GLSV-200B024

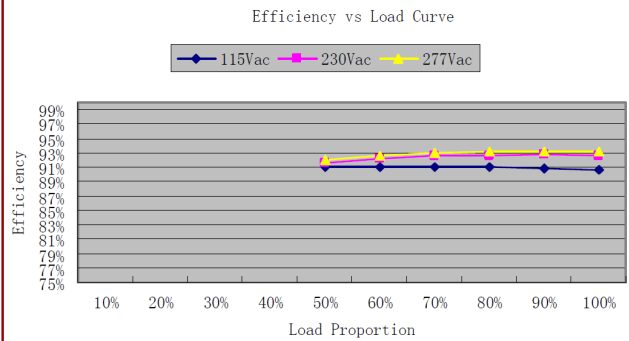

GLSV-200B036

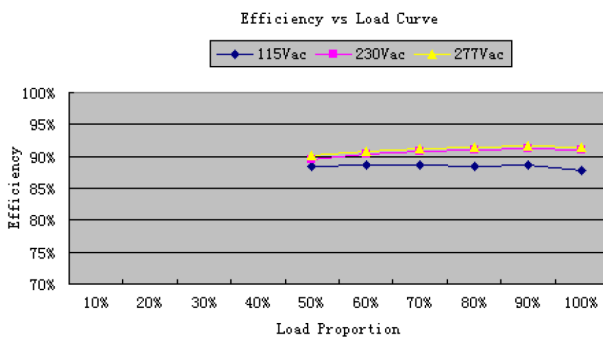

GLSV-200B048

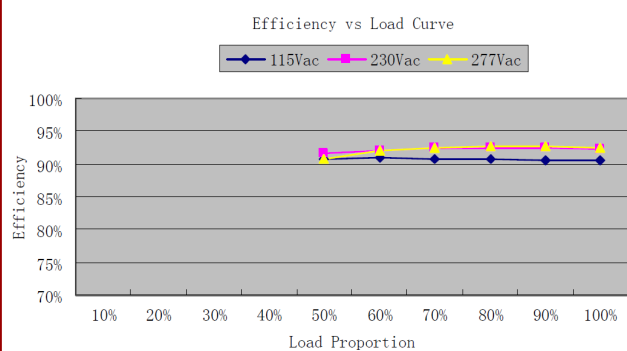

GLSV-200 series

200W Constant Voltage Outdoor LED Power Supply



© THD vs. Load Curve

GLSV-200B012

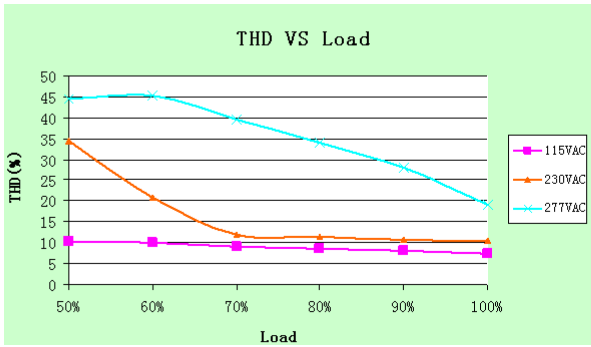

GLSV-200B024

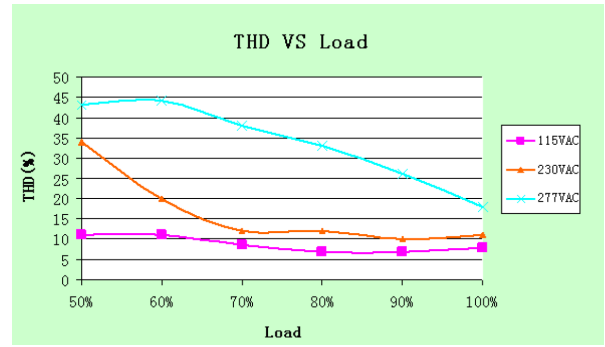

GLSV-200B036

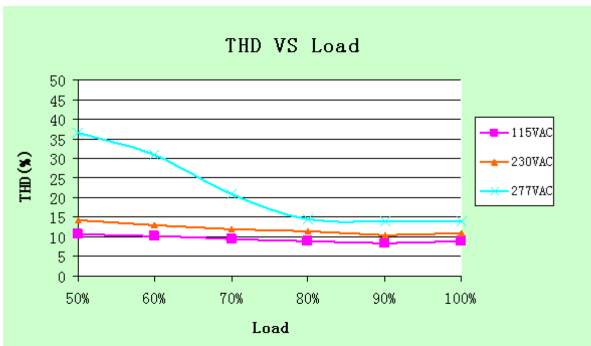

GLSV-200B048

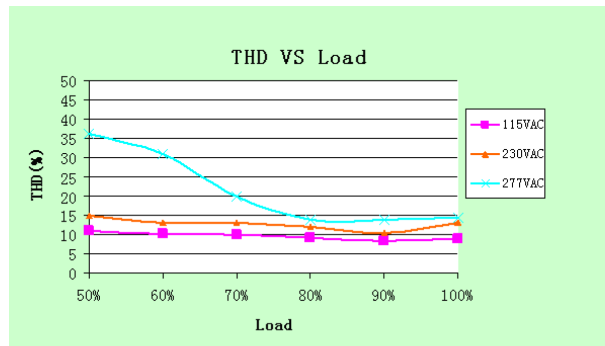

© Derating Curve

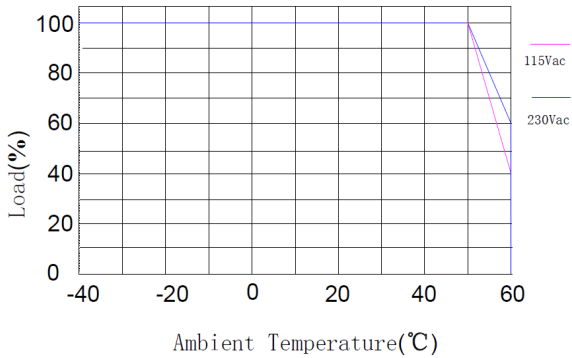

© Input Voltage vs. Load Curve

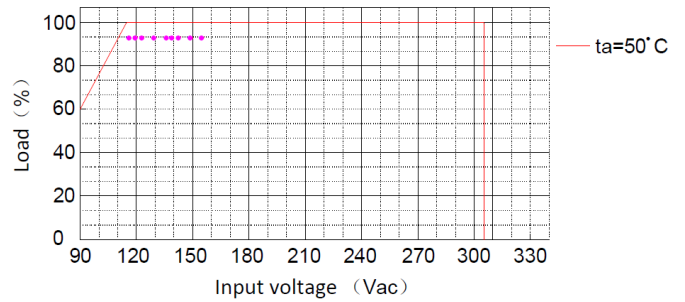

© Life time vs. T_c curve

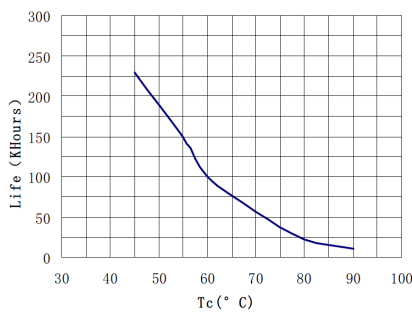

© Inrush Current Waveform

