

CATALOG

LED ACCESSORIES

2020

www.mwlighting.pl

LED PROFILES

AL12 series

LED PROFILES

AL12 series

Model	Reference photo	Q-ty	Material	Colour
AL12-GLS1		1000mm (1m)	Anodized aluminium	Grey, White, Black
		2020mm (2m)		
		3000mm (3m)		
		4150mm (4m)		

Profile plugs

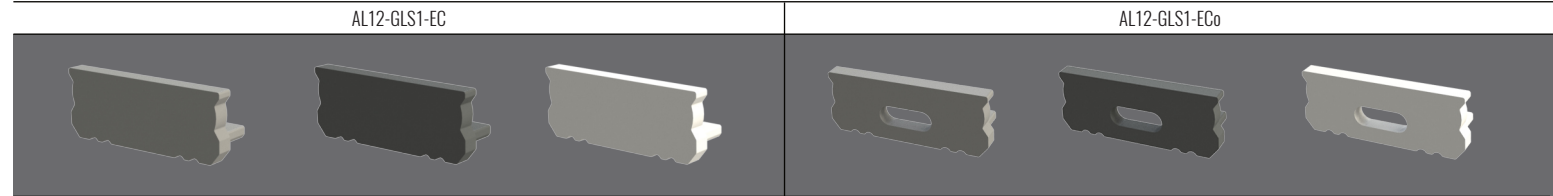

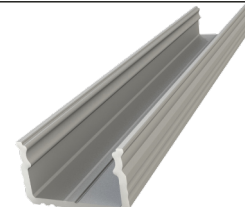
Model	Reference photo	Q-ty	Material	Colour
AL12-GLS2		1000mm (1m)	Anodized aluminium	Grey, White, Black
		2020mm (2m)		
		3000mm (3m)		
		4150mm (4m)		

Profile plugs

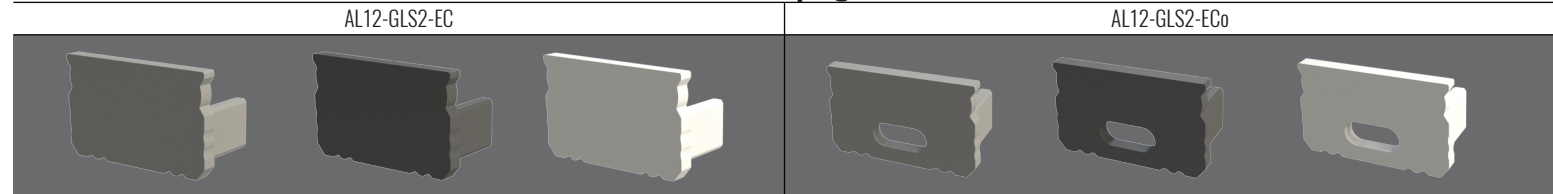

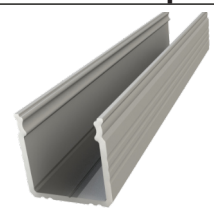
Model	Reference photo	Q-ty	Material	Colour
AL12-GLS3		1000mm (1m)	Anodized aluminium	Grey, White, Black
		2020mm (2m)		
		3000mm (3m)		
		4150mm (4m)		

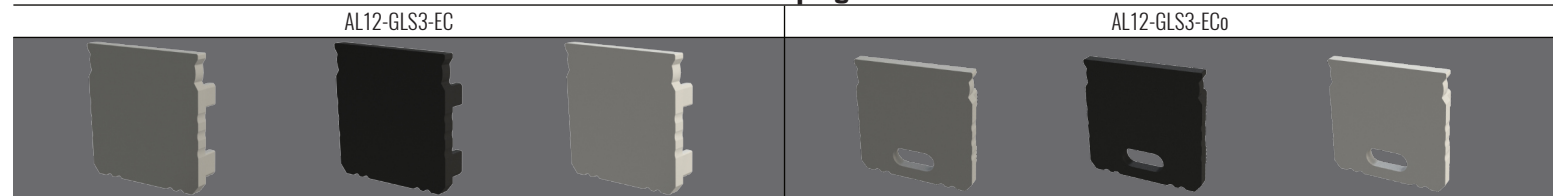

Profile plugs



Model	Reference photo	Q-ty	Material	Colour
AL12-GLG1		1000mm (1m)	Anodized aluminium	Grey, White, Black
		2020mm (2m)		
		3000mm (3m)		
		4150mm (4m)		

Profile plugs

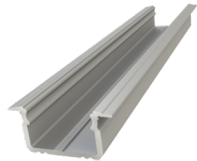
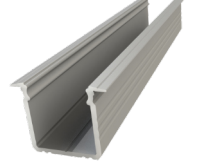
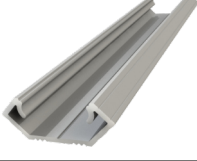





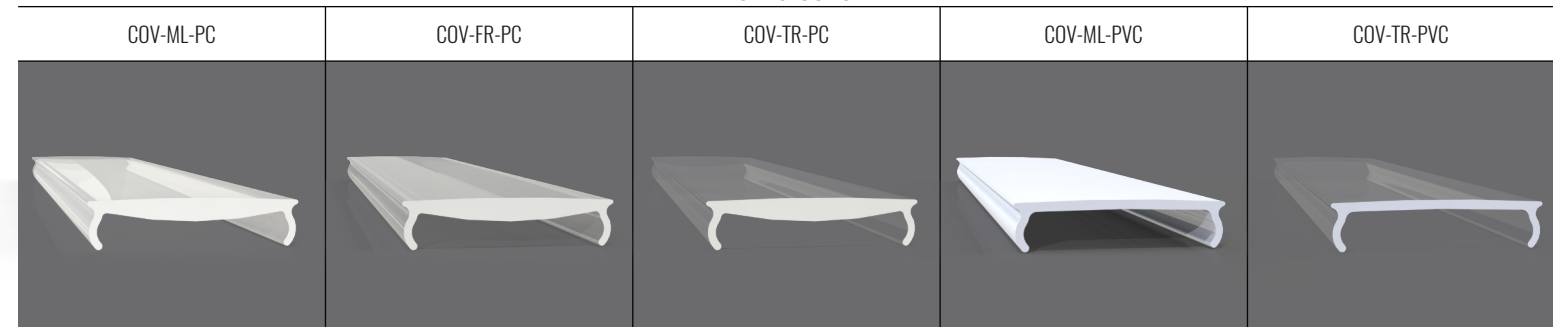

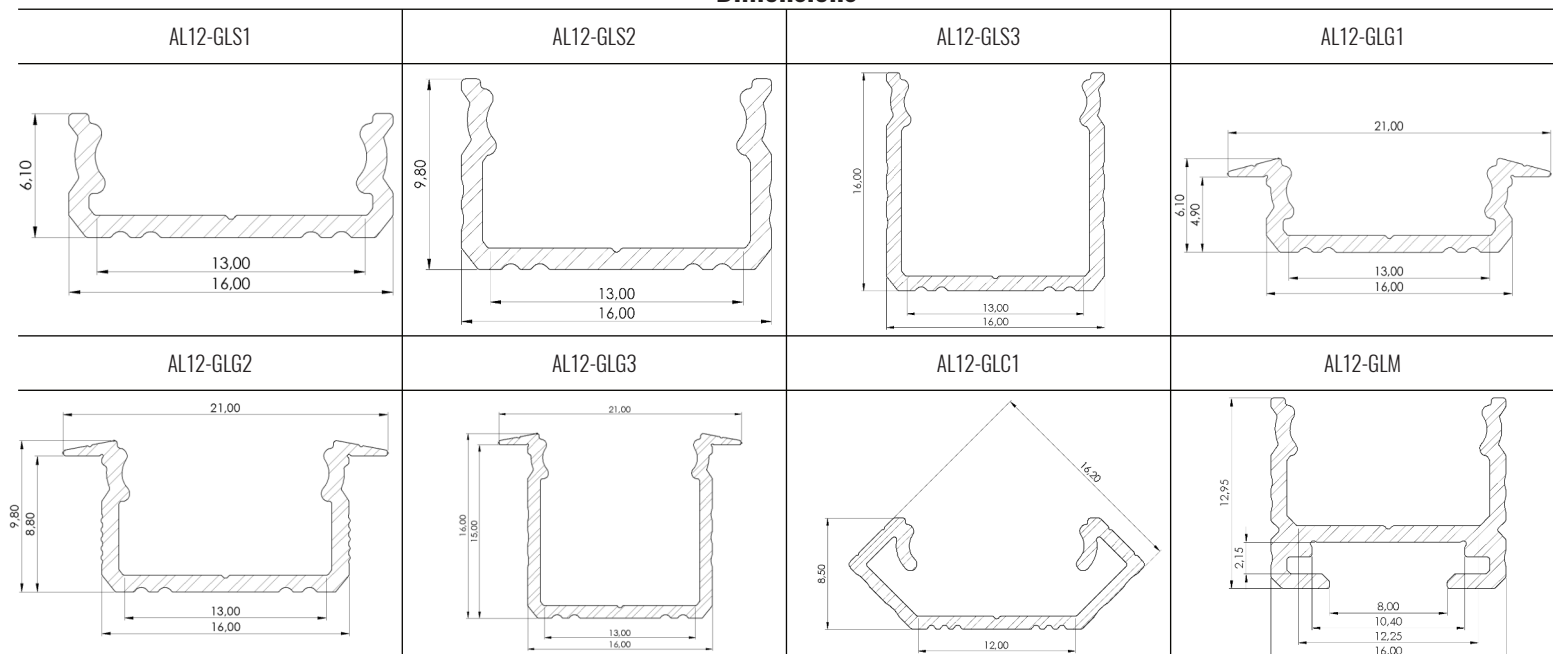

Model	Reference photo	Q-ty	Material	Colour
AL12-GLG2		1000mm (1m)	Anodized aluminium	Grey, White, Black
		2020mm (2m)		
		3000mm (3m)		
		4150mm (4m)		
AL12-GLG3		1000mm (1m)	Anodized aluminium	Grey, White, Black
		2020mm (2m)		
		3000mm (3m)		
		4150mm (4m)		
AL12-GLC1		1000mm (1m)	Anodized aluminium	Grey, White, Black
		2020mm (2m)		
		3000mm (3m)		
		4150mm (4m)		
AL12-GLM		1000mm (1m)	Anodized aluminium	Grey, White, Black
		2020mm (2m)		
		3000mm (3m)		
		4150mm (4m)		

Profile cover

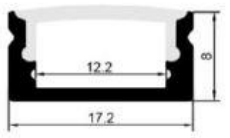
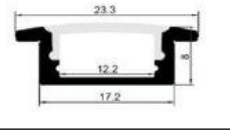
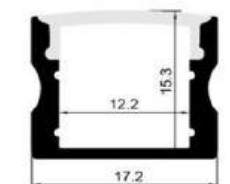
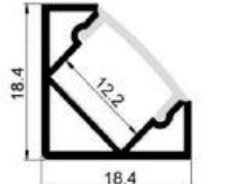

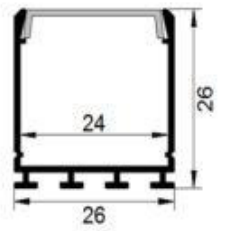
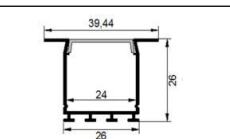
Dimensions



Model	Referance photo	Q-ty	Type	Colour
AL-ALPHA-OPAL-PC-2m		2m	PC cover	opal/milk
AL-ALPHA-SU-2m-ANODA		1pcs	Surface standard	silver anode
AL-ALPHA-SU-EC-GREY		1pcs	end cap	grey
AL-ALPHA-SU-EC-GREY-O		1pcs	end cap with hole	grey
AL-ALPHA-SU-MBm		1pcs	Mouting bracket metal	metal grey
AL-ALPHA-RE-2m-ANODA		2m	Recessed	silver anode
AL-ALPHA-RE-EC-GREY-O		1pcs	end cap	grey
AL-ALPHA-HI-2m-ANODA		2m	Surface high	metal grey
AL-ALPHA-HI-EC-GREY		1pcs	end cap	grey
AL-ALPHA-HI-EC-GREY-O		2m	end cap with hole	grey
AL-ALPHA-HI-MBm		1pcs	Mouting bracket metal	metal grey
AL-ALPHA-CO-2m-ANODA		2m	Corner 45deg	silver anode
AL-ALPHA-CO-EC-GREY		1pcs	end cap	grey
AL-ALPHA-CO-EC-GREY-O		1pcs	end cap with hole	grey
AL-ALPHA-CO-MBm		1pcs	Mouting bracket metal	metal grey
AL-GAMMA-OPAL-PC-2m		2m	PC cover	opal/milk
AL-GAMMA-SU-2m-ANODA		2m	Surface wide	silver anode
AL-GAMMA-SU-EC-GREY		1pcs	end cap	grey
AL-GAMMA-SU-EC-GREY-O		1pcs	end cap with hole	grey
AL-GAMMA-SU-EC-MBm		1pcs	Mouting bracket metal	metal grey
AL-GAMMA-RE-2m-ANODA		2m	Recessed wide	silver anode
AL-GAMMA-RE-EC-GREY-O		1pcs	end cap with hole	grey
AL-GAMMA-FL180		1pcs	flat junction 180deg	metal grey
AL-GAMMA-FL90		1pcs	flat junction 90deg	metal grey
AL-GAMMA-FL120		1pcs	flat junction 120deg	metal grey
AL-GAMMA-AN90		1pcs	angle junction 90deg	metal grey

Model	Referance photo	Q-ty	Type	Colour
HE-PLA-NA5-2m-SILVER		2m	Surface	silver aluminum anoda
HE-PLA-NA5-2m-BLACK		2m	Surface	black anoda
HE-PLA-NA5-2m-WHITE		2m	Surface	white lacquer
HE-END-NA5-SILVER		1pcs	end cap	silver aluminum anoda
HE-END-NA5-BLACK		1pcs	end cap	black anoda
HE-END-NA5-WHITE		1pcs	end cap	white lacquer
HE-UCH-NA5		1pcs	mounting bracket	silver-grey
HE-PLA-K5-2m-SILVER		2m	Corner	silver aluminum anoda
HE-PLA-K5-2m-BLACK		2m	Corner	black anoda
HE-PLA-K5-2m-WHITE		2m	Corner	white lacquer
HE-END-K5-SILVER-L		1pcs	end cap	silver aluminum anoda
HE-END-K5-BLACK-L		1pcs	end cap	black anoda
HE-END-K5-WHITE-L		1pcs	end cap	white lacquer
HE-END-K5-SILVER-P		1pcs	end cap	silver-grey
HE-END-K5-BLACK-P		1pcs	end cap	black
HE-END-K5-WHITE-P		1pcs	end cap	white
HE-PLA-WP5-2m-SILVER		2m	Recessed	silver aluminum anoda
HE-PLA-WP5-2m-BLACK		2m	Recessed	black anoda
HE-PLA-WP5-2m-WHITE		2m	Recessed	white lacquer
HE-END-WP5-SILVER		1pcs	end cap	silver-grey
HE-END-WP5-BLACK		1pcs	end cap	black
HE-END-WP5-WHITE		1pcs	end cap	white
HE-PLA-P05-2m-SILVER		2m	Surface	silver aluminum anoda
HE-PLA-P05-2m-BLACK		2m	Surface	black anoda
HE-PLA-P05-2m-WHITE		2m	Surface	white lacquer
HE-END-P05-SILVER		1pcs	end cap	silver-grey
HE-END-P05-BLACK		1pcs	end cap	black
HE-END-P05-WHITE		1pcs	end cap	white
HE-KL-WC1-MILK-2m		2m	Cover	milk-opal
HE-KL-WC1-FROST-2m		2m	Cover	frost
HE-KL-WC1-TRANSPARENT-2m		2m	Cover	transparent-clear

CONTROLLER

MW-CRT series

ACCESSORIES

FOR MIRRORS

Model	Photo	Voltage	Strip type	Output	Max Power	Control	Remote Keys
MW-CTR-RGB-2A-01		12V	RGB	3x 2A	72W	IR	24
MW-CTR-RGB-4A-01		12V		3x 4A	144W	RF	20
		24V					
MW-CTR-RGB-8A-01		12V		3x 8A	288W	RF	20
		24V					
MW-CTR-RGB-6A-01		12V		3x 6A	216W	RF	6 + RGB wheel
		24V					
MW-CTR-RGB-4A-02		12V		3x 4A	144W	RF	4 + RGB wheel
		24V					
MW-CTR-RGB-4A-Panel		12V		3x 4A	144W	RF + manual	6 + RGB wheel
		24V					
MW-CTR-RGB-4A-Panel-Eco		12V		3x 4A	144W	Manual	4 + RGB wheel
		24V					
MW-CTR-RGB-6A-02		12V		3x 6A	216W	RF	6 + RGB wheel
		24V	432W				
MW-CTR-MONO-6A-TX-01		12V	SINGLE / DUAL	none	none	RF	6 + wheel
		24V					
MW-CTR-MONO-6A-RX-01		12V	2x 6A	Single: 72W Dual: 120W	RF	none	
		24V					Single: 144W Dual: 240W
MW-CTR-RGBW-6A-TX-01		12V	RGBW	none	none	RF	8 + RGB wheel
		24V					
MW-CTR-RGBW-6A-RX-01		12V	4x 6A	288W	RF	none	
		24V					576W
MW-CTR-RGB-AMP-4A-01		12V	RGB	3x 4A	144W	none	none
		24V					
MW-CTR-RGB-AMP-8A-01		12V	3x 8A	288W	none	none	
		24V					576W
MW-CTR-MONO-8A-01		12V	SINGLE	1x 8A	96W	RF	3
		24V					
MW-CTR-MONO-8A-02		12V	1x 8A	96W	RF + manual	3+3	
		24V					192W
E-CONTROL-12V/24V-48/96W6P-WWCW-IR		12V	DUAL	2x 2A	48W	IR	6
		24V					
E-CONTROL-12V/24V-48/96W15P-WWCW-RF		12V	2x 2A	48W	RF	15	
		24V					96W

Model	Photo	Description
FDS06AFR		Black plastic housing for the weather station. It facilitates mounting the station directly on the mirror.
XM319-1		Touch module 1 on button
XM319-1-D		Touch module 1 button switch with dimming
XM319-2		Touch module 2 on/off buttons, control 2 devices at once
XM319-2-D		Touch module 2 on/off buttons with dimming, control 2 devices at once
XM319-3		Touch module 3 on/off buttons with dimming, control 3 devices at once
XM-R1		Relay dedicated to the heating mat. It allows us to switch on or off the power supply of the 230VAC heating mat on the voltage side of 12VDC
XM319-T		Clock and thermometer module. It has a temperature measurement sensor
XM518		Touch controller with display. Without Bluetooth Using the controller we can control the lighting, the heating mat and the radio.
XM518-BT		Touch controller with display with integrated Bluetooth module Using the controller we can control the lighting, the heating mat and the radio.
XM518-BTSP		Touch controller with display with integrated Bluetooth module Using the controller we can control the lighting, the heating mat and the radio.
BT BOX		A set of 2 speakers. Works with XM319-T, XM319-2-D and Bt Box.
SP-MX518		Black plastic housing for the weather station. It facilitates mounting the station directly on the mirror.

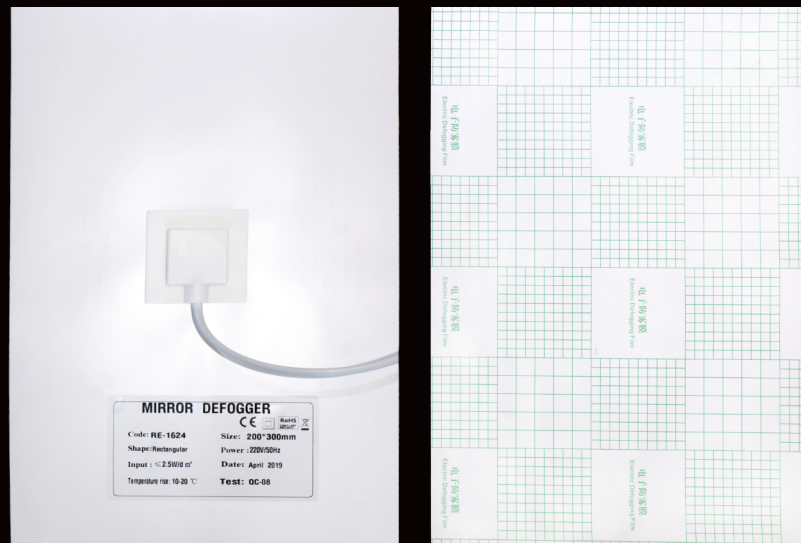

Application:

- It prevents fogging the mirror
- Quick and easy installation
- Low power consumption

Application:

- 7.3-inch LED display
- Wi-Fi network to get accurate time and date
- Wi-Fi receives real-time weather forecast (weather conditions, temperature and humidity, temperature range)
- Indoor temperature detection
- Today and tomorrow weather forecast display (optional)
- LED brightness is adjustable
- LED night mode
- Firmware upgrade function

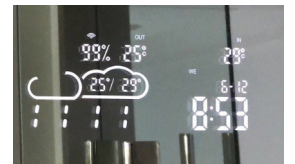
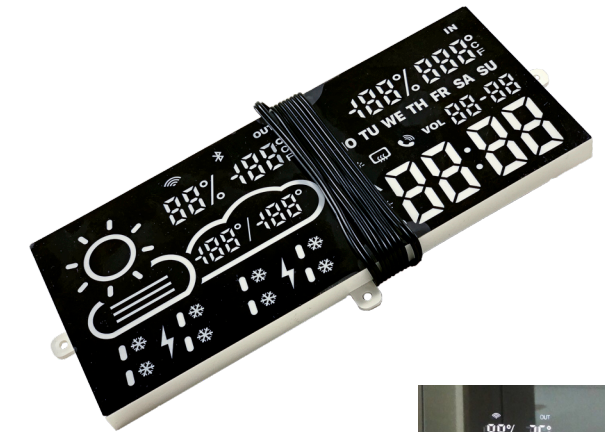

Model	3020	4030	6040	8050
Size	30cm x 20cm	40cm x 30cm	60cm x 40cm	80cm x 50cm
Input Voltage	230V / 50Hz			
Input Power	1.5 ÷ 2.5W/dm ²			
Power	9 ÷ 15W	18 ÷ 15W	36 ÷ 15W	60 ÷ 15W
Averaged power consumption	10.93W	29.41W	38.59W	74.53W
Average value of temperatura rising	10°C ÷ 20°C			
Wire	OMYp 2x0.5mm2 (2x20AWG)			
Wire lenght	1.5mb			
Material	PET (Dupont)			
Heating surface	0,06m ²	0,12m ²	0,24m ²	0,40m ²
Thickness	3mm			
Evaporation time	From 1 to 10 minutes			
Sticking strength	0.5kg/cm2			
Softening	180°C			
Hot melting temperature is over	260°C			
Warranty	2 years			

Working Environment

Working Temperature	-25°C ÷ 60°C
Working Humidity	10 ÷ 90% RH non-condensing
Storage Temperature and Humidity	-20°C ÷ 85°C, 5 ÷ 90% RH non-condensing
Degree of IP protection	IP54

Model	
Working voltage	DC 12V/24V
Display	7.3-inch LED display
The maximum power of the whole machine	6W
Shell size	18.6cm x 8.8cm x 1.1cm
Dehydrated silver area size	16.6cm x 6.8cm

Application note

This module is equipped with WiseMirror APP to easily configure the mirror weather module, such as connecting a WiFi router, setting local area and temperature unit settings, and viewing the real-time temperature in the room on the WiseMirror APP.

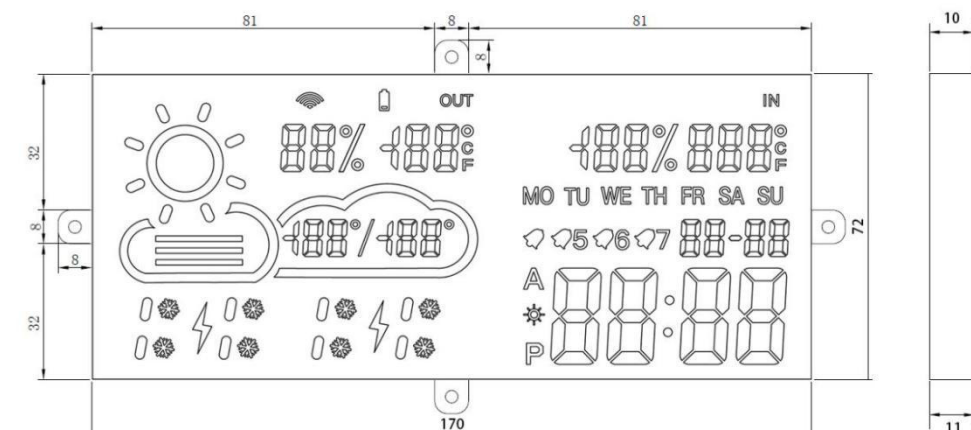

CONTROLLER

HE series

Model	Photo	Voltage	Strip type	Output	Max Power	Control	Remote Keys
HE-WDL-1		12V	Mono	1x 5A	60W	Touch	ON/OFF
HE-WDL-2		12V					ON/OFF
HE-WDLS-3		12V					ON/OFF brightness
HE-WDLS-4		12V		1x 8A	96W	Move sensor	ON/OFF brightness
HE-WZBLS-1		12V					ON/OFF brightness
HE-WZBLS-2-IR		12V					ON/OFF brightness
HE-WDP-M1 black		230Vac	SINGLE / DUAL RGB / RGBW	2A	500W	Touch click	ON/OFF monostable
HE-WDP-M1 white							
HE-WDP-M2 black							
HE-WDP-M2 white							
HE-WDP-4A-IR		12Vdc	Mono	1x 2.5A	30W	Move (Surface sensor)	ON/OFF monostable
HE-WDP-4B-IR		12Vdc					
HE-WDP-5A-IR		12Vdc					
HE-WDP-5B-IR		12Vdc					
HE-WUN-1-IR (black case)		12Vdc					
HE-WUN-1-IR (white case)		12Vdc		1x 5A	60W	Move	ON/OFF bistable monostable











CONTROLLER

HE series

Model	Photo	Voltage	Strip type	Output	Max Power	Control	Remote Keys	
HE-WZB-2C-IR		230Vac	Mono	1A	250W	Move	ON/OFF bistable	
HE-WZB-4A-IR		12Vdc		1x 2.5A	30W	Move (Surface sensor)		ON/OFF brightness
HE-WZB-4B-IR								
HE-WDS-1 alu								
HE-WDS-1 black		12Vdc		Mono	1x 1.5A	18W	Touch	ON/OFF brightness
HE-WDS-2 max					1x 5A	60W		
HE-WDS-3					1x 4A	48W		
HE-WBL-3 (For MDF 18mm)					1x 5A	60W		
HE-WBLS-4 (For MDF 18mm)		230Vac		-	1x 2A	-	Manual	ON/OFF
HE-WP-1 black								
HE-WP-1 white								
HE-WN-315 black								
HE-WN-315 gold								
HE-WK-MR2 (R13) black			1x 8A		-	-	-	-
HE-WK-MR2 (R13) white								
HE-WK-MR2 (R13) grey								
HE-WK-MR2 (R13) brown								



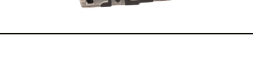













CONNECTORS

4S series

Model	Photo	PCB	Strip type	Junction type	Wire length
4S-CON-WS-8mm		8mm	Non-waterproof	Strip + wire	none
4S-CON-WS-10mm		10mm			
4S-CON-WS-10mm-DUAL		10mm			
4S-CON-WS-10mm-RGB		10mm			
4S-CON-WS-12mm-RGBW		12mm			
4S-CON-WS-8mm-WP		8mm	Gel waterproof	Strip + wire	
4S-CON-WS-10mm-WP		10mm			
4S-CON-WS-10mm-RGB-WP		10mm			
4S-CON-WS-12mm-RGBW-WP		12mm			
4S-CON-SS-8mm		8mm			
4S-CON-SS-10mm		10mm			
4S-CON-SS-10mm-DUAL		10mm			
4S-CON-SS-10mm-RGB		10mm			
4S-CON-SS-12mm-RGBW		12mm			















CONNECTORS

CLICK series

Model	Photo	PCB	Strip type	Junction type	Wire length
CLICK-8A		8mm	Non-waterproof	Single side + wire	10cm
CLICK-10A		8mm			
CLICK-10A-RGB		10mm			
CLICK-10C-RGB		10mm			
CLICK-8A-WP		8mm	Gel waterproof	Single side + wire	10cm
CLICK-10A-WP		10mm			
CLICK-8B		8mm	Non-waterproof	Double side	none
CLICK-10B		8mm			
CLICK-10B-RGB		10mm			
CLICK-8B-WP		8mm	Gel waterproof	Double side	none
CLICK-10B-WP		10mm			
CLICK-8C		8mm	Non-waterproof	Double side + wire	10cm
CLICK-10C		8mm			
CLICK-10C-RGB		10mm			
CLICK-8C-WP		8mm	Gel waterproof	Double side + wire	10cm
CLICK-10C-WP		10mm			

CONNECTORS

CLICK series

Model	Photo	PCB	Strip type	Junction type	Wire length			
CLICK-8L		8mm		90deg curve				
CLICK-10L		8mm						
CLICK-10L-RGB		10mm						
CONT-8L		8mm						
CONT-10L		10mm						
CLICK-8T		8mm				Non-waterproof	3-way connection	none
CLICK-10T		10mm						
CLICK-10T-RGB		10mm						
CONT-8T		8mm						
CONT-10T		10mm						
CLICK-8X		8mm	4-way connection					
CLICK-10X		10mm						
CLICK-10X-RGB		10mm						
4S-CONWP-2-WH-SET		2-pin		Wire-wire (Up to 300V)				
4S-CONWP-4-BL-SET		4-pin						

In addition, in the offer

LED modules

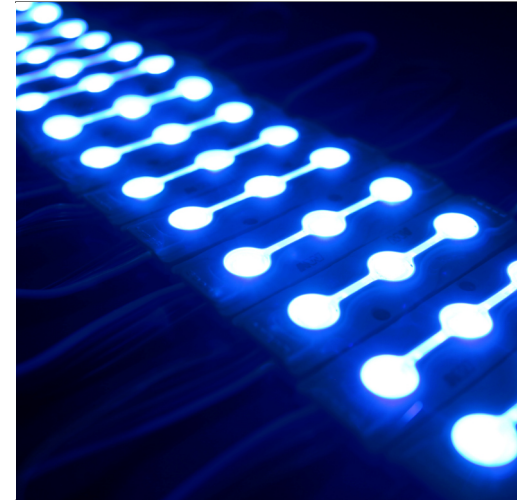

LED strips

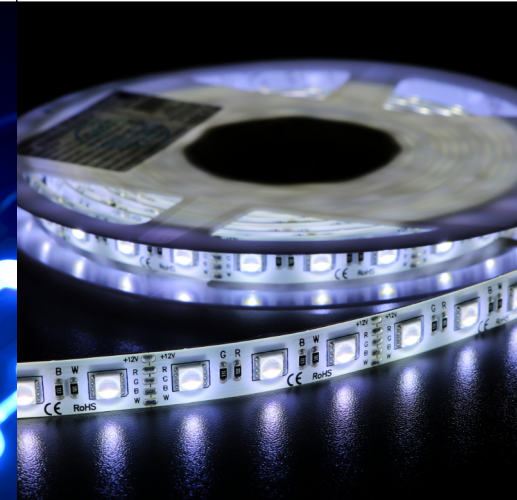

NEON Flex

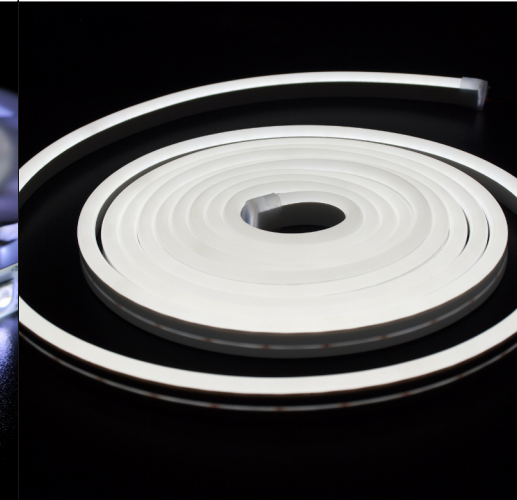

GLP power supplies

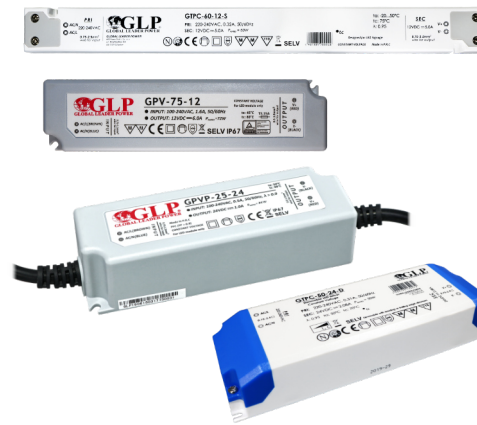

POS power supplies



ADLER power supplies



Desktop MWPow



For more information, visit our website www.mwlighting.pl or contact your sales representative

Table of contents

LED PROFILES

AL12 series

s.02-03

LED PROFILES

AL series

s.04

LED PROFILES

HE series

s.05

CONTROLLER

MW-CRT series

s.06

ACCESSORIES

FOR MIRRORS

s.07

HEATING MATS FOR MIRRORS

DFG series

s.08

WEATHER MODULE FOR MIRROR

FDS-06A model

s.09

CONTROLLER

HE series

s.10-11

CONNECTORS

4S series

s.12

CONNECTORS

CLICK series

s.13-14

OTHER MWL BRAND PRODUCTS

LED modules, LED strips, NEON Flex, GLP power supplies, POS power supplies, ADLER power supplies, MWPOWER Desktop

s.15